



Installation Guide for 2x1 10/100BaseT Regeneration Tap

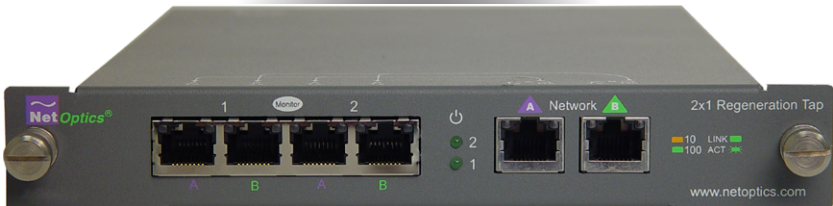

Table of Contents

Introduction	1
Key Features	2
Product Diagrams	3
Application Diagrams	5
Connecting the 2x1 10/100 Regeneration Tap to the Network	6
Connecting the 2x1 10/100 Regeneration Tap to to the Monitoring Devices	7
Specifications	8
Order Information	9
Warranty	10

PLEASE READ THESE LEGAL NOTICES CAREFULLY.

By using a Net Optics Regeneration Tap you agree to the terms and conditions of usage set forth by Net Optics, Inc.

No licenses, express or implied, are granted with respect to any of the technology described in this manual. Net Optics retains all intellectual property rights associated with the technology described in this manual. This manual is intended to assist with installing Net Optics products into your network.

Trademarks and Copyrights

© 2006 by Net Optics, Inc. Net Optics® is a registered trademark of Net Optics, Inc. Additional company and product names may be trademarks or registered trademarks of the individual companies and are respectfully acknowledged.

Additional Information

Net Optics, Inc. reserves the right to make changes in specifications and other information contained in this document without prior notice. Every effort has been made to ensure that the information in this document is accurate. Net Optics is not responsible for typographical errors.

Introduction

Net Optics 2x1 10/100BaseT Regeneration Taps solve the key physical layer challenges of multi-device monitoring for 10/100BaseT networks. For a complete picture of network health, these Taps connect two different network management and security devices at any single network location.

One Tap, No Idle Resources

Keep your intrusion detection and prevention systems, protocol analyzers, RMON probes, and other security devices productive with a single Regeneration Tap. Maximize resources and save on access points when multiple devices can monitor link traffic simultaneously through a single Regeneration Tap. Secure, passive access for multiple devices simply means a better return on monitoring investments.

Zero Delay™ - A Net Optics Breakthrough

Highly sensitive network locations can improve monitoring performance via the innovative features of Net Optics Taps. If power is lost to other 10/100 Taps, the connected devices may introduce delays as they detect the power loss and try to re-establish their link.

Net Optics' pioneering design ensures that any loss of power to the Tap is transparent to the network, and does not affect the flow of traffic through the Tap – eliminating packet delay and loss as potential security issues.

Security and Visibility

Without an IP address, monitoring devices are isolated from the network, dramatically reducing their exposure to attacks. However, the monitoring device connected to the Tap still sees all full-duplex traffic as if it were in-line, including Layer 1 and Layer 2 errors.

Reliability

For extra uptime protection, Net Optics Taps offer redundant power connections. Should the primary power source fail, the Tap automatically switches to the backup power source. Power LEDs on the front of the Tap indicate the current power.

Key Features

Passive, Secure Technology

- Enables real-time, simultaneous monitoring of a single 10/100BaseT link with two monitoring devices
- Provides complete full-duplex visibility at 10 or 100 Mbps without data stream interference or introducing a point of failure
- Unique Zero Delay technology ensures every packet goes through without delay, even if power is lost to the Tap
- Passes all traffic (including errors) from all layers for comprehensive troubleshooting
- No IP address is needed for the Tap or monitoring device, enhancing monitoring security
- Redundant power ensures monitoring uptime
- Fully IEEE 802.3 compliant
- Fully IEEE RoHS compliant

Ease of Use

- LED indicators show redundant power, speed, link, and activity status
- Front-mounted connectors support easy installation and operation
- Silk-screened application diagram illustrates all connections for easy deployment
- Optional custom monitoring cables support easy full-duplex monitoring by sending each side of the signal to a separate monitoring device NIC
- Tested and compatible with all major manufacturers' monitoring devices, including protocol analyzers, probes, and intrusion detection/prevention systems

Support

- Net Optics offers free technical support throughout the lifetime of your purchase. Our technical support team is available from 8 am to 5 pm Pacific Time, Monday through Friday at +1 (408) 737-7777 and via email at ts-support@netoptics.com. FAQs are also available on Net Optics website at www.netoptics.com.

Product Diagram-Front

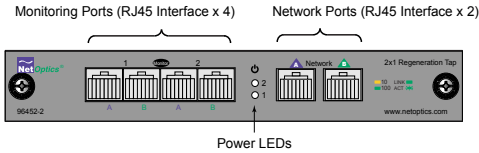

Figure 1: Front Panel View

LED Functions

- **PWR 1/ PWR 2:** Main and Redundant Power. If the Tap is deployed with both power supplies, both LEDs will illuminate green when the Tap is plugged in. If an LED is off, this indicates that the corresponding power supply is not functioning.
- **10/100 Indicator:** Located in the upper left hand corner. If the Port is set to 10 Mbps, the LED illuminates yellow. If the Port is set to 100 Mbps, the LED will illuminate green.
- **Link Indicator:** Located in the upper right hand corner. If a good link is established, the LED illuminates a steady green. If there is current activity on this link, the LED flashes.

Product Diagram-Back

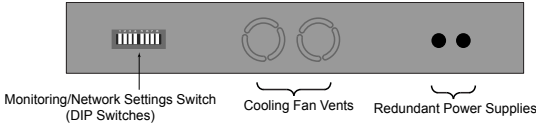
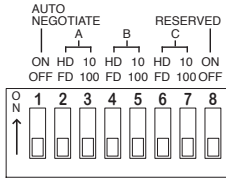

Figure 2: Rear Panel View



NOTE: To activate, push buttons UP.
(This diagram shows all segments in the OFF position)

Monitoring/Network Settings

Eight dual in-line package (DIP) switches are located on the back of the unit, allowing the user to select from multiple monitoring and network settings. When the bottom half of the switch is down, the Port is “Off.” When the top half of the switch is down, the Port is “On.” You must ensure that both Network Ports A and B match your network devices speed and duplex settings.

- **Switch 1: Autonegotiation.** When this Port is “On” the Tap can change between monitoring at either 10 or 100 Mbps, depending on the dictates of the connected monitoring devices. When this Port is “Off” the Tap is forced to operate only at 10 Mbps, or at 100 Mbps, depending on the position of Switch 2.
- **Switch 2: Half or Full-Duplex.** When this Port is “Off” the Tap supports full-duplex communication. When this Port is “On” the Tap supports half-duplex communication.
- **Switch 3: 10 or 100 Mbps.** When this Port is “Off” the Tap is set to communicate with all connected devices at 100 Mbps. When this Port is “On” the Tap is set to communicate at 10 Mbps. This setting is overridden when Autonegotiation (Switch 1) is “On.”
- **Switch 4:** Reserved
- **Switch 5:** Reserved
- **Switch 6:** Reserved
- **Switch 7:** Reserved
- **Switch 8:** Reserved

Note: Factory default setting is Auto-negotiation.

Application Diagram

Example Regeneration Tap Implementation

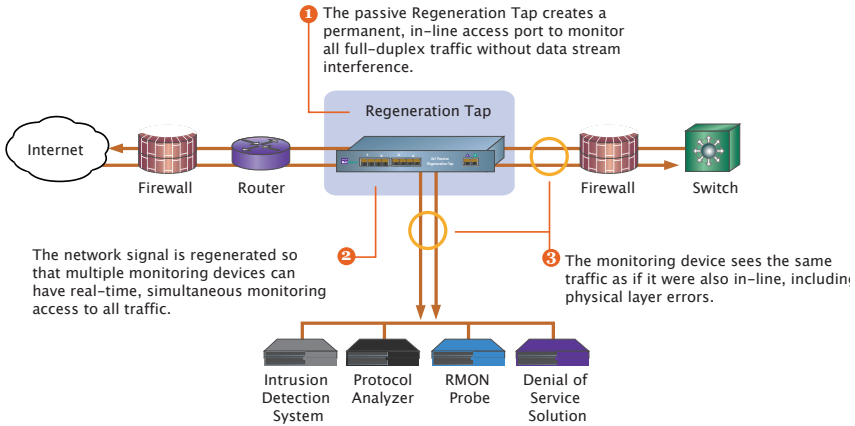

Copyright © 1996-2003 Net Optics, Inc.

Figure 3: Network Application Diagram

Connecting the 2x1 10/100BaseT Regeneration Tap to the Network

1. Unpack the Regeneration Tap and verify that you have all components. Obtain the necessary cables needed to install the unit.
2. Connect Network Port A to the appropriate switch, server or router device using a CAT5 RJ45. This will act as your DCE Interface.
3. Connect Network Port B to the appropriate switch, server or router device using a CAT5 RJ45. This will act as your DTE interface.
4. Verify that the Regeneration Tap Network Ports are cabled in-line between the two devices.

Note: Straight-thru cable is used when connecting the Tap Ports to a Router or NIC. Cross-over cable is used when connecting the Tap Ports to Switches and Hubs. The Tap Ports Transmit on Pins 3&6 and Receive on Pins 1&2.

1 Connect Copper Network Ports

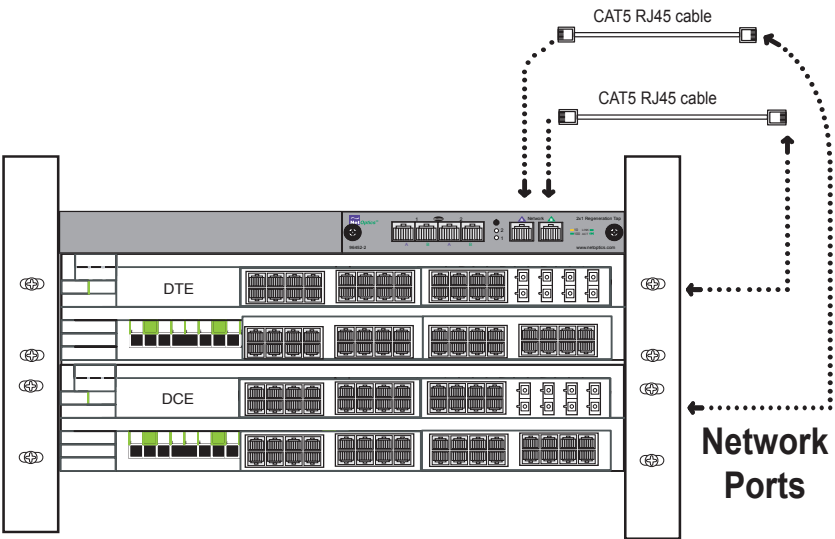
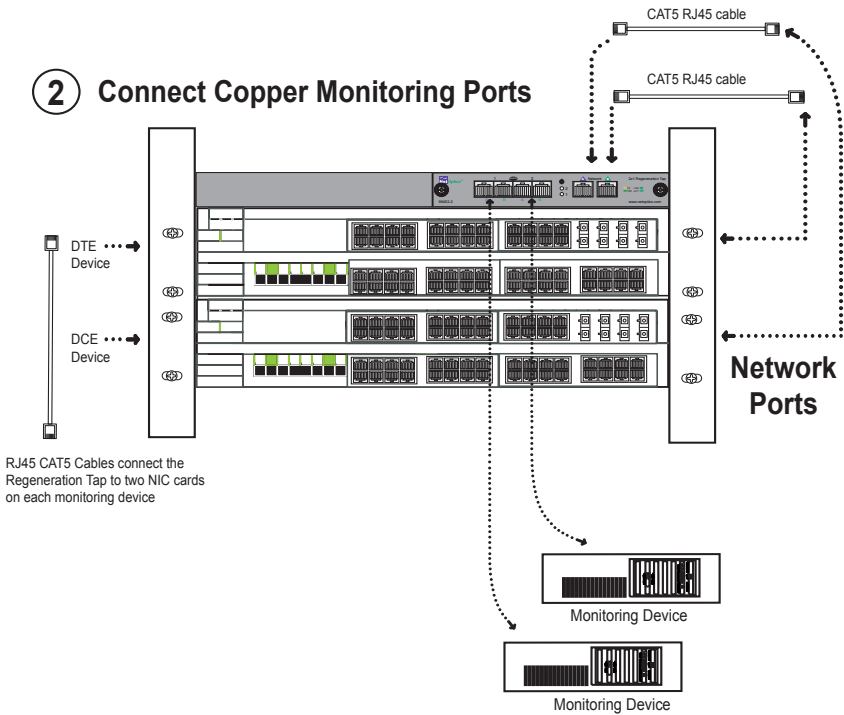

Figure 4: Tap to Network Connection

Connecting the 2x1 10/100 BaseT Regeneration Tap to the Monitoring Devices

1 Connect Copper Network Ports

2 Connect Copper Monitoring Ports



RJ45 CAT5 Cables connect the Regeneration Tap to two NIC cards on each monitoring device

Note:
A 2x1 10/100 Regeneration Tap can support real-time, simultaneous monitoring with up to two devices.

Figure 5: Tap to Monitoring Devices

Specifications

Operating Specifications:

Operating Temperature: 0°C to 55°C

Storage Temperature: -10°C to 70°C

Relative Humidity: 10% min, 95% max, non-condensing

Mechanical Specifications:

Redundant Power Supplies:

Input: 100-240VAC, 0.5A, 47-63Hz

Output: 12 V, 1.5A

Dimensions: 1.25" high x 9.75" deep x 6.5" wide

Cable Interface:

Copper Cable Type: 22-24 AWG unshielded twisted pair cable,
CAT5/CAT5E

Link Distance Supported: 100 meters

Certifications:

Fully RoHS compliant

Connectors:

(4) RJ45, 8 pin connectors (monitoring ports)

(2) RJ45, 8 pin connectors (network ports)

Limitations on Warranty and Liability

Net Optics offers a limited warranty for all its products. IN NO EVENT SHALL NET OPTICS, INC. BE LIABLE FOR ANY DAMAGES INCURRED BY THE USE OF THE PRODUCTS (INCLUDING BOTH HARDWARE AND SOFTWARE) DESCRIBED IN THIS MANUAL, OR BY ANY DEFECT OR INACCURACY IN THIS MANUAL ITSELF. THIS INCLUDES BUT IS NOT LIMITED TO LOST PROFITS, LOST SAVINGS, AND ANY INCIDENTAL OR CONSEQUENTIAL DAMAGES ARISING FROM THE USE OR INABILITY TO USE THIS PRODUCT, even if Net Optics has been advised of the possibility of such damages. Some states do not allow the exclusion or limitation of implied warranties or liability for incidental or consequential damages, so the above limitation or exclusion may not apply to you.

Net Optics, Inc. warrants this Regeneration Tap to be in good working order for a period of one year from the date of purchase from Net Optics or an authorized Net Optics reseller.

Should the unit fail anytime during the said one year period, Net Optics will, at its discretion, repair or replace the product. This warranty is limited to defects in workmanship and materials and does not cover damage from accident, disaster, misuse, abuse or unauthorized modifications.

If you have a problem and require service, please call the number listed at the end of this section and speak with our technical service personnel. They may provide you with an RMA number, which must accompany any returned product. Return the product in its original shipping container (or equivalent) insured and with proof of purchase.

THE WARRANTY AND REMEDIES SET FORTH ABOVE ARE EXCLUSIVE AND IN LIEU OF ALL OTHERS, EXPRESS OR IMPLIED. No Net Optics reseller, agent, or employee is authorized to make any modification, extension, or addition to this warranty.

Net Optics is always open to any comments or suggestions you may have about its products and/or this manual.

Send correspondence to
Net Optics, Inc.
1130 Mountain View Alviso Road
Sunnyvale, CA 94089-2237 USA
Telephone: +1 (408)737-7777
Fax: +1 (408)745-7719
Email: info@netoptics.com
Internet: www.netoptics.com

All Rights Reserved. Printed in the U.S.A. No part of this publication may be reproduced, transmitted, transcribed, stored in a retrieval system, or translated into any language or computer language, in any form, by any means, without prior written consent of Net Optics, Inc., with the following exceptions: Any person is authorized to store documentation on a single computer for personal use only and that the documentation contains Net Optics' copyright notice.

www.netoptics.com